

For: Long Life Integral Release Bolt Double Diaphragm Spring Brakes

Several design improvements and specification changes have been made to the LTR-T 2.50 inch stroke model. These changes were effective on **June 1, 1998**. They impact the **LTR2430T** and **LTR3030T**. Those improvements and changes are:

1. The END CAP and RETAINER are eliminated on all LTR-T models.
2. The NECK on top of the brake is slightly longer, and MACHINED GROOVES at the top of the neck are eliminated because the END CAP and RETAINER are no longer necessary.
3. New DACROMET COATING on the release bolt mechanism ensures complete corrosion protection and less required effort for caging the brake.
4. New 8-gauge Non-Pressure Chamber.
5. New O-RING SEAL design keeps contamination out of the spring chamber.

The new LTR2430L3 and LTR3030L3 (3 inch stroke) models include all of these design features listed above, with the exception of the external breather tube.

⚠ WARNING: Your MGM brakes tamper resistant spring brake has been factory sealed for your protection. There are no user-serviceable parts inside the spring brake chamber. If you experience any damage or failure of your spring brake chamber, remove either the entire actuator as in Section (3) of this manual, or the single (piggyback) as in Section (5) of this manual. See Section (8) of this manual for disposal instructions. Never attempt to disassemble the spring brake chamber as serious personal injury could result from accidental sudden release of the high energy spring.

SECTION (1): RECOMMENDED INSPECTION POINTS

- (A) The END COVER CAP on the LTR-T model, pre 6/1/98, requires no positioning or maintenance, but must be snapped tightly into place. Inspect the cap for damage and replace as necessary. **Operating units equipped with the BREATHER TUBE, without the END COVER CAP securely in place, will void the MGM Brakes Warranty without remedy.**
- (B) Visually inspect the exterior surfaces of the unit for signs of damage from outside sources, corrosion and/or rust. If any of these are seen or suspected, cautiously remove the complete combination chamber by following the directions in Section (3) of this manual. Per CVSA out of service criteria any unmanufactured hole or crack will place the vehicle out of service. (Not Shown)
- (C) Inspect SERVICE BRAKE CLAMP BAND to be sure it is securely in place and damage free. If any damage is seen or suspected, cautiously remove the complete piggyback/spring brake chamber by following directions in Section (5) of this manual. **MGM Brakes recommends 30-35 Lbs.-Ft. torque on CLAMP BOLTS.**
- (D) Check to ensure the MOUNTING STUD NUTS are tightened to **133-155 Lbs.-Ft. torque (clockwise)** and washers are in place between the nut and the bracket.
- (E) Inspect air lines, hoses and fittings attached to chamber. Replace any damaged or leaking parts. **MGM Brakes recommends the fittings be tightened to 25 Lbs.-Ft. torque into the chamber air inlet ports.**

IMPORTANT - Inspect the air ports to determine the model of brake. Round ports denote (2.50 inch) standard stroke model, square ports denote (3.00 inch) long stroke model. This information is important when replacing the service diaphragm and determining the chamber's rated stroke.

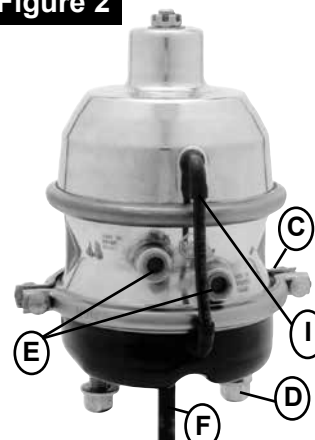
- (F) Inspect the PUSH-ROD to be sure it is working free, not bent, not binding and is square to the chamber bottom within $\pm 3^\circ$ in any direction at any point in the stroke of the chamber. If the PUSH-ROD is not square, make corrections by repositioning the chamber on the mounting bracket and/or by shimming the slack adjuster to the right or left on the camshaft as required.
- (G) Inspect the YOKE ASSEMBLY being sure YOKE PIN is installed and locked into place with a COTTER PIN. Replace any damaged, worn or missing parts. **MGM Brakes recommends the YOKE LOCKNUT be tightened to 25-35 Lbs.-Ft. torque. (Not Shown)**
- (H) On units equipped with a DUST BOOT, check the BOOT for damage and replace as necessary. (Not Shown).
- (I) On units equipped with an external BREATHER TUBE (Figure 1 & 2) check elbows for damage and replace as necessary. Ensure both ends of the connector tube are engaged a minimum of 1/2-inch into each of the flexible elbows. The tube must be glued to both of the elbows with a high quality rubber adhesive or secured with a clamp that may be purchased with an MGM Brakes BREATHER TUBE KIT. These units must be mounted with the BREATHER TUBE in the upper half of the non-pressure chamber facing away from the road surface (Figure 9).

Figure 1



**Model LTR-T Pre 6-1-98
2.50 Inch Stroke**

Figure 2



**Model LTR-T Post 6/1/98
2.50 Inch Stroke**

Figure 3



**Model LTR-L3
3 Inch Stroke**

IMPORTANT: Failure to operate the “LTR-T” 2.50 inch stroke chamber without the EXTERNAL BREATHER TUBE securely in place and in good condition will void the MGM Brakes Warranty without remedy.

SECTION (2): MANUAL RELEASE - PARKING BRAKES

- Before releasing brakes, chock wheels of the vehicle to prevent a runaway.
- For the LTR-T, pre 6/1/98, remove the end cover cap (figure 4). The post 6/1/98 LTR-T and new LTR-L3 do not have an end cover cap.
- Turn the integral release bolt counter-clockwise using 15/16-inch wrench (figure 5) until the power spring is fully caged and make sure the push-rod is retracted (**DO NOT USE AN IMPACT WRENCH**). When the brake is fully caged the release bolt should be extended out as tabulated below (figure 6):

LTR-T pre 6/1/98	2.50 inch minimum	Type 24 and 30 Chambers
LTR-T post 6/1/98	3.24 inch	Type 24 and 30 Chambers
LTR-L3	3.24 inch	Type 24 and 30 Chambers

WARNING: Do not exceed these lengths and do not exceed 50 Lbs.-Ft torque on release- nut at any time or damage may occur which could prevent any further correct manual releasing of the piggyback spring brake chamber.

NOTE: For easier manual caging and releasing, apply 90-100 psi air pressure to inlet port marked “Spring Brake” before Step (c) above.

SECTION (3): REMOVAL AND INSTALLATION INSTRUCTIONS FOR “COMBINATION CHAMBERS”

NOTE: Refer to Section (4) before removing existing air brake chamber to ensure that the brake chamber was properly installed with the correct rod length.

- Determine the manufacturer of the single (piggyback) spring brake or combination chamber to be removed from the vehicle and, following that manufacturer’s instructions exactly, manually release the spring brake completely. Instructions for the LTR-T and LTR-L3 with integral release bolt are given in Section (2) of this manual. Service Manuals for all design series of MGM Brakes piggyback/spring brakes are also available upon request to MGM Brakes.
- Remove the cotter pin from the yoke pin, knock out the yoke pin, and remove both air lines from the assembly.

IMPORTANT - Be sure to mark the air line from the inlet port marked “SPRING BRAKE” for later re-installation reference.

- Using a 15/16-inch wrench, unscrew hex nuts on mounting bolts and cautiously remove the old chamber from the mounting bracket.
- Follow procedure to cut the service push-rod to proper length (Refer to Section 4).**
- Remove the hex nuts and the flat washers on the mounting bolts of the new chamber, clean the face of the mounting bracket and install the chamber on the bracket with close attention given to positioning the chamber air inlet ports for correct alignment to the vehicle air lines. Then install one flat washer and hex nut on each mounting bolt and using a 15/16-inch hand wrench (**DO NOT USE AN IMPACT WRENCH**), tighten nuts to **MGM Brakes recommended 133-155 Lbs.-Ft. torque.**

IMPORTANT - If it is required to reposition the air inlet ports to assure proper mating and alignment with vehicle air lines, refer to Section (5) of this manual and follow Steps (c) through (f) very carefully.

- Reconnect yoke to the slack adjuster, making sure that the correct diameter and length of yoke pin is installed into the correct hole in the slack adjuster. Secure the yoke pin with a new cotter pin.
- Inspect the push-rod to be sure that it is working free, not bent, not binding and is square to the chamber bottom within $\pm 3^\circ$ in any direction at any point in the stroke of the chamber. If the push-rod is not square, make corrections by repositioning the chamber on the mounting bracket and/or by shimming the slack adjuster to the right or left on the camshaft as required.

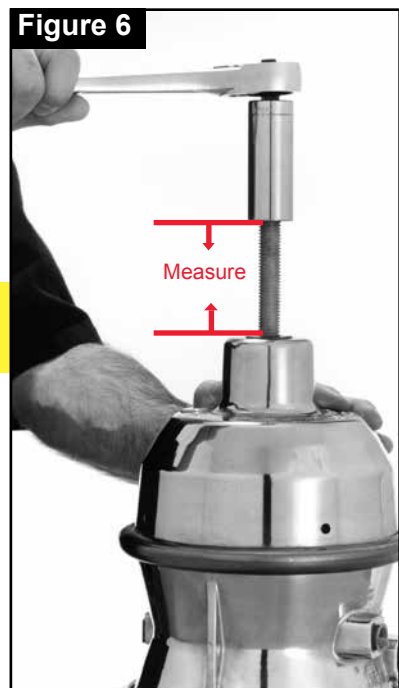
Figure 4

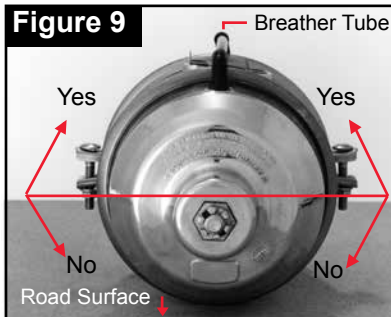
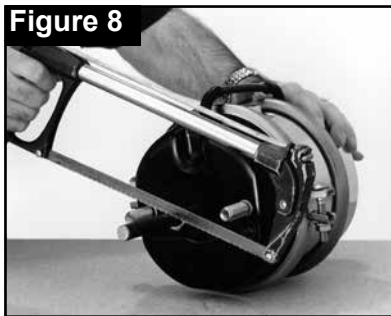
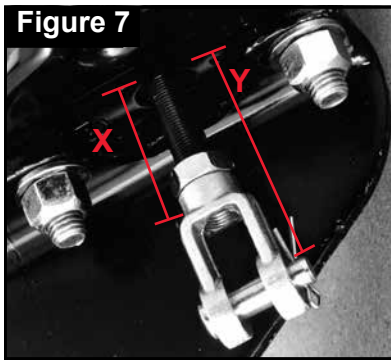


Figure 5



Figure 6





- (h) Apply a non-hardening sealing compound to the hose fittings and re-install both of the air lines to the chamber making sure each is mated to the correct air inlet port according to markings made earlier. **MGM Brakes recommends the fittings be tightened to 25-30 Lbs.-Ft. torque into the chamber air-inlet ports.**
- (i) Using vehicle system air, charge the spring brake with full line pressure (minimum 100 psi). Using only soapy water or leak detection solution (NEVER ANY TYPE OF OIL!) inspect for air leaks at the air lines and fittings. If bubbles appear, tighten fittings slightly, but not over 30 Lbs.- Ft. torque.

IMPORTANT - If the service brake clamp band was loosened to reposition air inlet ports in Step (e) above, apply air to the spring brake and then apply and hold foot brake treadle valve down to charge the service brake chamber. Test for air leaks around the circumference of the service clamp band. If bubbles appear, firmly tap the circumference of the clamp band with a hammer and retighten the clamp nuts until leaks cease (Figure 17). MGM Brakes recommends 30-35 Lbs.-Ft. torque on clamp hex nuts. Completely exhaust air from both of the chambers when complete.

- (j) With air pressure applied to spring brake section, activate power spring by turning the release bolt clockwise until the bolt is fully engaged into the unit and the slotted nut bottoms out on the head insert. **Tighten to 45-50 Lbs.-Ft. torque (DO NOT USE AN IMPACT WRENCH).**
- (k) Replace the END CAP properly on LTR-T models, pre 6/1/98 (Figure 11). **Operating units equipped with the EXTERNAL BREATHING TUBE, without the END CAP securely in place, will void the MGM Brakes Warranty without remedy.**

IMPORTANT - If chamber is fitted with an external breather tube be sure both ends of the connector tube are engaged a minimum of 1/2-inch into each of the flexible elbows. The tube must be glued to both of the elbows with a high quality rubber adhesive or secured with a clamp that may be purchased with an MGM Brakes BREATHING TUBE KIT. These units must be mounted with the breather tube facing away from the road surface (Figure 9).

WARNING - After replacement of any brake chamber, the chamber push-rod stroke and actuating alignment must be checked to assure correct installation and foundation brake adjustment. It is very important to recognize that no foundation brake adjustments can be made at either the spring brake chamber, or at the service brake chamber, and that all "stroke adjustments" must be made at the slack adjuster according to the specific recommendations of the foundation brake manufacturer or of the vehicle manufacturer.

SECTION (4): PROCEDURE TO CUT THE SERVICE PUSH-ROD TO PROPER LENGTH

WARNING: Do not attempt to service or disassemble the spring chamber on any spring brake actuator. A large spring in the spring chamber having extreme force could cause serious bodily injury if it were suddenly released due to inadvertent removal of this clamp or tamper resistant head.

IMPORTANT - Place blocks under wheels to prevent vehicle rollaway before removing air brake actuators.

- (a) REMOVE WORN OR NON-FUNCTIONAL UNIT FROM VEHICLE: Determine manufacturer and model of unit to be replaced. Refer to that manufacturer's service manual for caging and removal instructions.
- (b) Make sure the spring chamber of the removed actuator is fully released (power spring caged) and the service brake push-rod is fully retracted to zero stroke position (i.e. brake fully released).
- (c) Measure and record the "X" and "Y" dimensions (See Figure 7).

"X" Dimension - The dimension from bottom of actuator to end of push-rod.
 "Y" Dimension - The dimension from bottom of actuator to centerline of yoke pin.

NOTE: If for some reason the spring chamber power spring cannot be caged and fully released, then the "X" and "Y" dimensions will need to be measured from another actuator of the exact type from the same vehicle provided it is retracted to its zero stroke position (brake fully released) and was operating correctly.

- (d) Before marking push-rod to be cut on a new unit, be sure the spring chamber and push-rod are fully retracted to the zero stroke position. (This may be done with the integral caging bolt or by applying 90-100 psi air pressure to the spring chamber air inlet port).
- (e) Take measured "X" dimension from the removed unit and mark push-rod of new unit from the bottom of the actuator.
- (f) Thread yoke jam nut past mark on push-rod. Align bottom edge of nut with mark.
- (g) Use a sharp hacksaw and cut push-rod on the mark (Figure 8).
- (h) After cutting rod, thread jam nut off to clean up cut thread.
- (i) Thread jam nut back onto the push-rod a sufficient length to allow assembly of the yoke.
- (j) Thread yoke onto the push-rod. Yoke from removed unit may be reused provided yoke pin hole is not worn. Adjust yoke to the same "Y" dimension as measured from the removed unit.
- (k) Hold yoke to prevent it from turning and tighten jam nut against yoke to 25-35 Lbs.-Ft. torque. **TO INSTALL NEW UNIT ON VEHICLE:** Refer to MGM Brakes Service Manual for the model that is being installed. Refer to Section (3) of this manual for LTR-T and LTR-L3 Models.

Figure 11



IMPORTANT - When installing any MGM Brakes model with the breather tube it is mandatory to position the breather tube away from the road surface (Figure 9). Failure to comply will void the MGM Brakes Warranty on these models.

IMPORTANT - When making a reconnection to an automatic slack adjuster follow the vehicle manufacturer's recommendations for installation and set-up

SECTION (5): REMOVAL AND INSTALLATION INSTRUCTIONS FOR SINGLE (PIGGYBACK) SPRING BRAKES

Warning: Installation of any MGM Brakes LTR-T or LTR-L3 model must be made only on an MGM Brakes heavy duty 8 gauge non-pressure chamber or weld reinforced non-pressure chamber. Failure to comply will void the MGM Brakes Warranty for these models.

The removal and installation of a single spring brake chamber (without removal of the service brake chamber) can be made easier by "locking off" the service chamber push-rod. To do this apply the service brake by applying the driver's foot brake treadle valve and, while applied, clamp vise-grip pliers on push-rod to prevent rod from retracting when air pressure is released (Figure 13).

- (a) Manually release the spring brake completely. Instructions for the LTR-T and LTR-L3 with integral release bolt are given in Section (2) of this manual. Service Manuals for all other design-series of MGM Brakes single spring brakes are also available upon request to MGM Brakes.
- (b) Remove both air lines from the chamber.

IMPORTANT - Be sure to mark the air line from the inlet port marked "SPRING BRAKE" for later re-installation reference.

- (c) On all MGM Brake Models fitted with external breather tubes (Figures 1 & 2), disconnect the tube and elbow from the service chamber housing (Figure 16).
- (d) Using a 9/16-inch wrench or socket, remove the clamp nuts on the service clamp band. Then, while holding the single spring brake securely in place, remove the clamp band to allow removal of the single spring brake from the service chamber (Figure 14).

IMPORTANT - At this time take the opportunity to inspect and replace all parts in the service chamber which may be damaged or worn, especially the diaphragm and return spring. Use only genuine MGM Brakes engineered replacement parts!

IMPORTANT: Make sure that the existing non-pressure chamber is either an MGM Brakes heavy-duty 8-gauge NPC or weld reinforced NPC. Replace the non-pressure chamber if not equipped as recommended above. Failure to comply will void the MGM Brakes Warranty for these models.

- (e) Make sure the new single (piggyback) spring brake is fully released as outlined in Section (2) of this manual. Position the diaphragm in the bottom recess of the chamber (Figure 15). **Assure** all mating parts are aligned straight. Position the inlet ports to mate with the vehicle air supply lines and replace the service clamp band (Figure 14).

Figure 12

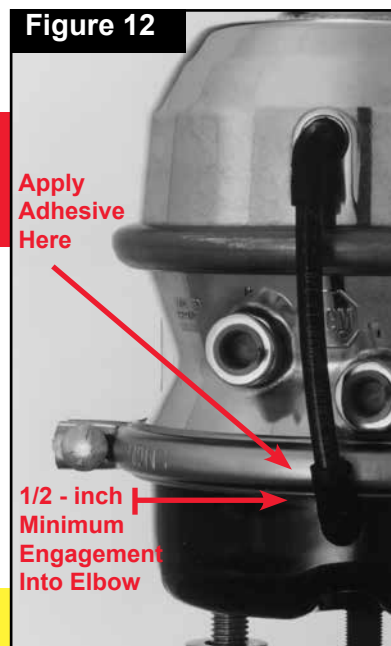


Figure 13

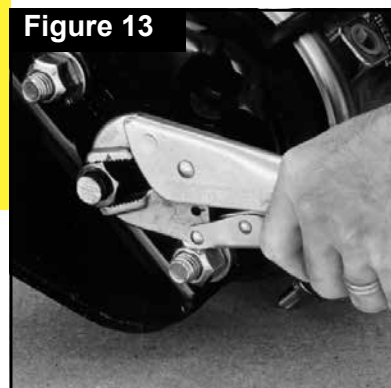


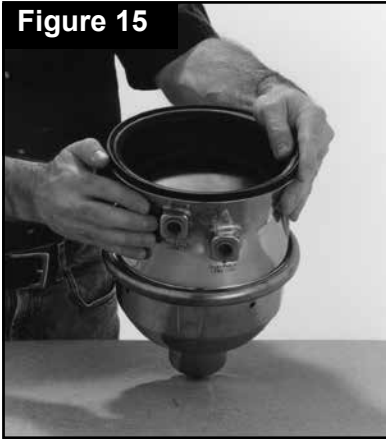
Figure 14



- (f) Re-install the clamp bolts and nuts. **Alternately tighten each nut in 5-10 Lbs.-Ft. torque increments** while constantly rechecking mating parts alignment. If re-alignment is required, loosen clamp nuts and repeat Step (e) above. Firmly tap around circumference of the clamp band with a hammer to assure the full seating of the clamp (Figure 17) and **tighten the nuts to 30-35 Lbs.-Ft. torque.**
- (g) Apply a non-hardening sealing compound to the hose fittings and re-install both of the air lines to the chamber, making sure each is mated to the correct air inlet port according to markings made earlier. **MGM Brakes recommends the fittings be tightened to 25-30 Lbs.-Ft. torque into the chamber air inlet ports.**
- (h) Using vehicle system air, charge the parking brake with full line pressure (minimum 100 psi). Using only soapy water or leak detection solution (NEVER ANY TYPE OF OIL!) inspect for air leaks at the air lines and fittings. **If bubbles appear, tighten fittings slightly, but not over 30 Lbs.-Ft. torque.**
- (i) With the spring brake still fully charged with full line pressure, apply and hold foot brake treadle valve down to charge the service brake chamber.

IMPORTANT - At this time, remove the vise-grip pliers (Figure 13) from the service push-rod so that the push-rod can return to a normal position in the chamber. Now test for air leaks around the circumference of the service clamp band. If bubbles appear, firmly tap the circumference of the clamp band with a hammer and retighten the clamp nuts until leaks cease (Figure 17). MGM Brakes recommends 30-35 Lbs.-Ft. torque on the clamp hex nuts.

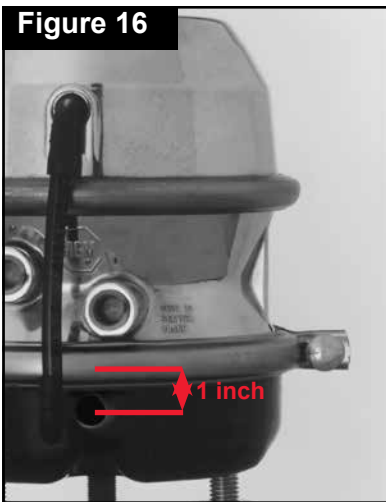
Figure 15



IMPORTANT - On all MGM Brakes models fitted with an EXTERNAL BREATHING TUBE, remove and replace elbow in NPC if damaged or worn. Remove by carefully pulling on elbow. Install elbow by pinching end and inserting through elbow hole in head or NPC. Then pull back until it snaps securely in place.

- (j) Wipe the open end of the connector tube clean to be sure that no oil is present, apply a high quality rubber adhesive to the tube and re-insert tube into flexible elbow with minimum 1/2-inch engagement into both elbows (Figure 12). If the old single unit was not equipped with an EXTERNAL BREATHING TUBE, drill a 1/2-inch diameter hole 1 inch from the top of the non-pressure chamber (Figure 16), at a point closest to the centerline between the air-inlet ports (Figure 12). Remove any burrs around the hole and install a new rubber elbow in the non-pressure chamber (see installations above). Wipe the open end of connector tube clean to be sure no oil is present. Apply a high quality rubber cement to the tube and insert the tube into the flexible elbow with a minimum 1/2-inch engagement into the elbow (Figure 16).

Figure 16



IMPORTANT - These units must be mounted with the BREATHING TUBE facing away from the road surface and the tube glued or clamped securely into the rubber elbows (Figure 9). Failure to comply with these installation instructions will void the MGM Brakes Warranty without remedy.

- (k) If replacing with the LTR-L3 in place of the LTR-T, the addition of the breather tube is not necessary.
- (l) With air pressure applied to spring brake section, activate power spring by turning the release bolt clockwise until the bolt is fully engaged into the unit and the slotted nut bottoms out on the head insert. **Tighten to 45-50 Lbs.-Ft. torque (DO NOT USE AN IMPACT WRENCH).**
- (m) Replace the END CAP properly on LTR-T models, pre 6/1/98 (Figure 11). **Operating these units without the END CAP securely in place will void the MGM Brakes Warranty without remedy.**

SECTION (6): REMOVAL AND INSTALLATION INSTRUCTIONS FOR "SERVICE BRAKE DIAPHRAGM"

Figure 17



- (a) Follow all instructions given in Section (5) of this manual and install the new diaphragm at Step (5-e). Use only genuine MGM Brakes engineered replacement diaphragms!

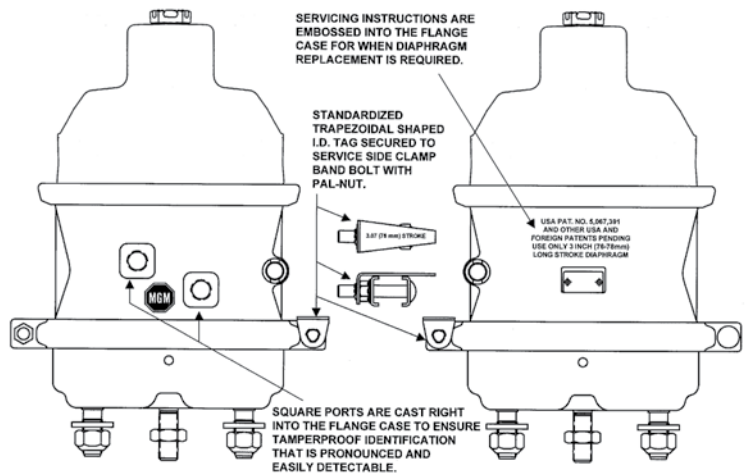
! WARNING - When servicing a 3-inch "long stroke" model brake, be sure to replace with the correct diaphragm. Installation of a standard (2.50 inch) stroke diaphragm in a 3-inch "long stroke" chamber could result in catastrophic failure of the unit.

IMPORTANT - It may not be necessary to disconnect the air lines from the spring brake during this procedure as long as correct and straight parts alignment can be obtained during the reassembly operations.

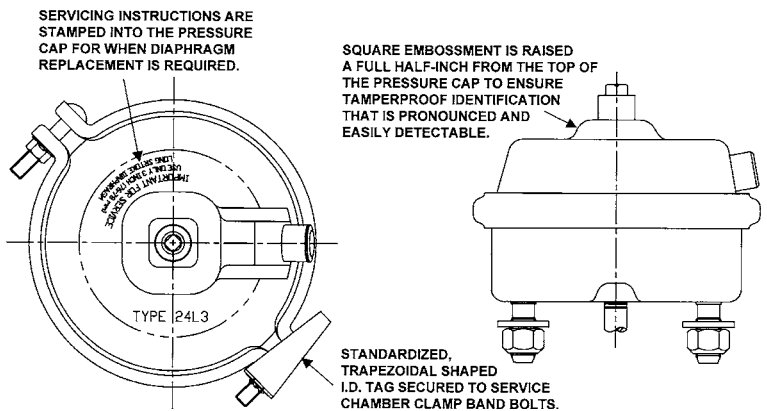
SECTION (7): LONGSTROKE SPRING BRAKE & SERVICE CHAMBER IDENTIFICATION

IMPORTANT - Inspect the ports to determine the model of brake. Round ports denote (2.50 inch) standard stroke model, square ports denote (3.00 inch) longstroke model.

**‘LONG-STROKE’
SPRING BRAKE
IDENTIFICATION**



**‘LONG-STROKE’
SERVICE CHAMBER
IDENTIFICATION**



SECTION (8): RECOMMENDED SPRING BRAKE ACTUATOR DISARMING PROCEDURE

WARNING: This procedure must be strictly adhered to. Never attempt to remove the spring chamber clamp band from a double diaphragm actuator or the spring chamber retaining ring from a piston actuator. Both actuators employ a high energy power spring that could cause serious bodily injury if the spring were suddenly released due to improper disassembly.

All retired spring brake actuators must be safely disarmed before they are disposed of to prevent serious personal injury from accidental sudden release of the high energy spring (as much as 2700 Lbs.) in the parking chamber. To disarm the unit, remove it from the vehicle following the instructions in Section (3) for combination chambers, or Section (5) for single piggyback chambers. Be sure to release the parking brake per Section (2) of this manual. Never attempt to remove the head, which contains the power spring. Observe all safety precautions. Place the unit in a steel container (*) and use an acetylene torch to cut a hole through the head housing the power spring. Cut completely through at least two spring coils. The steel containers must have openings to expose the head where it is to be cut with the acetylene torch and it must be strong enough to prevent parts from hurtling out should the unit suddenly separate before it is safely disarmed. It is the users responsibility to ensure the steel container is safe.

*Information concerning a suitable container is available through your MGM Brakes Representative.



A Division of Indian Head Industries, Inc.
6200 Harris Technology Blvd. • Charlotte, NC 28269
(704) 547-7411 • (800) 527-1534 • (704) 547-9367 Fax
www.mgmbrakes.com

Form # 5042 Rev. 4/16
© 2000 MGM Brakes
All Rights Reserved
Printed in U.S.A.